

 trafimet



ERGOPLUS



Update of the classic

The highly renowned ERGOPLUS MIG gun has been updated to a new standard. In addition to the new ergonomic design, significant improvements have been made to the welding performance of the ERGOPLUS MIG torch.

**Evoluzione del classico** [it]

La rivoluzionata torcia MIG ERGOPLUS è stata rinnovata ad un nuovo standard. Oltre al nuovo design ergonomico, sono stati apportati importanti miglioramenti alle prestazioni di saldatura della torcia MIG ERGOPLUS.

Update des Klassikers [de]

Wir haben unseren renommierten ERGOPLUS MIG-Brenner komplett optimiert und erneuert. Neben dem neuen ergonomischen Design wurde auch die Schweißleistung des ERGOPLUS MIG-Brenners erheblich verbessert.

Mise a jour de la gamme classique [tr]

Hautement renommée, la torche de soudage MIG ERGOPLUS a bénéficié d'une actualisation avec une nouvelle norme. Outre la nouvelle conception ergonomique, des améliorations significatives ont été apportées aux performances de soudage de la torche MIG ERGOPLUS.

Bir klasiğin güncellenmesi [fr]

Kaynak ürünleri pazarında son derece ünlü ERGOPLUS MIG torçları yeni bir standardı karşılayacak şekilde yenilendi. Yeni ergonomik tasarıma ek olarak, ERGOPLUS MIG torçlarının kaynak performansında da önemli iyileştirmeler yapıldı.



Ergonomia ed esperienza [it]

L'impugnatura della nuova torcia ERGOPLUS è composta da due componenti (gomma e plastica). Le parti in gomma si trovano sulla parte superiore e inferiore, dove la mano del saldatore esegue la presa in modo naturale e preciso. La presa naturale della mano del saldatore - una forma triangolare in due direzioni - è il principio che ha guidato la progettazione dell'impugnatura della torcia ERGOPLUS dall'inizio alla fine.

Ergonomie und Benutzererlebnis [de]

Der Griff des neuen ERGOPLUS besteht aus zwei Komponenten, Gummi und Kunststoff. Die Gummitexturen befinden sich auf der Ober- und Unterseite der Griffoberfläche, wo die Hand den Griff natürlich und präzise halten muss. Die natürliche Griffposition der Hand – ein Dreieck wie abgebildet – war von Anfang bis Ende das Leitprinzip bei der Gestaltung des ERGOPLUS-Griffs.

Ergonomie et expérience utilisateur [fr]

La poignée de la nouvelle torche ERGOPLUS est composée de deux éléments en caoutchouc et en plastique. Des textures en caoutchouc sont situées sur la partie supérieure et inférieure des surfaces de la poignée, aux endroits où la main humaine doit tenir la poignée naturellement et avec précision. La position naturelle de la main humaine – une forme triangulaire dans deux directions – a constitué le principe directeur tout au long de la conception de la poignée de l'ERGOPLUS.

Ergonomi ve kullanıcı deneyimi [tr]

Yeni ERGOPLUS kabza, kauçuk ve plastik olmak üzere iki bileşenden oluşur. Kabza üzerindeki kauçuk dokular, operatörün kabzayı doğal ve hassas bir şekilde tutabilmesine olanak sağlayacak şekilde kabzanın üst ve alt yüzey alanlarında bulunur. İnsan elinin doğal konumu (iki yönlü üçgen bir şekil) ERGOPLUS kabza tasarımında baştan sona ana ilke olarak benimsenmiştir.

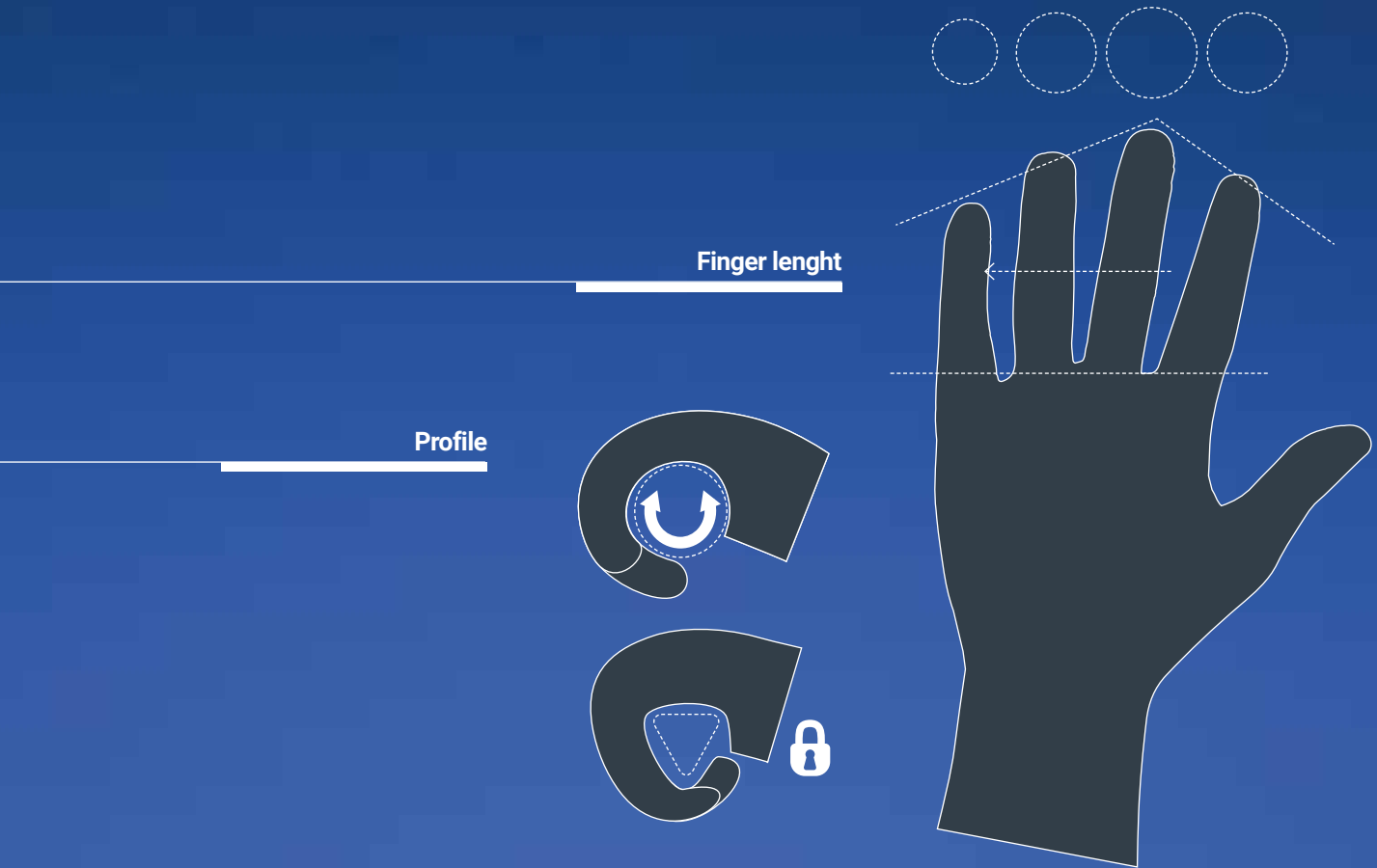

Ergonomics and user experience

The handle of the new ERGOPLUS is made of two components, rubber and plastic. Rubber textures are located on the top and the underside of the handle surface areas, where the human hand needs to hold the handle naturally and precisely. The natural position of the human hand—a triangular shape in two directions—has been the leading principle in designing the handle of the ERGOPLUS from start to finish

Handle geometry

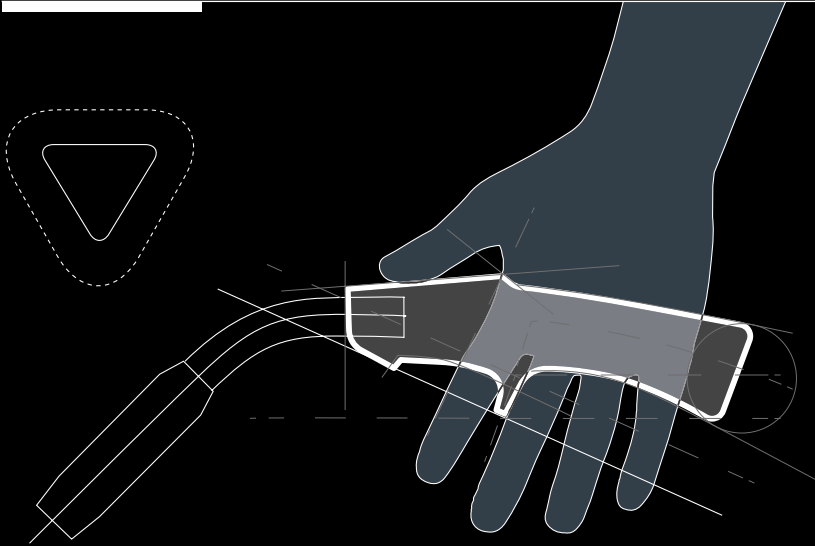

Bilanciamento della torcia [it]

ERGOPLUS fornisce due diversi tipi di supporto per lo snodo dal design ergonomico: uno per i modelli raffreddati ad acqua e uno per i modelli raffreddati ad aria. Il doppio giunto sferico usato con le torce raffreddate ad acqua rende i movimenti della torcia illimitati e mantiene l'intero prodotto in perfetto equilibrio. Sulle versioni della torcia raffreddate ad aria è presente un supporto a molla in plastica progettato in modo efficiente. La soluzione a molla in plastica fornisce sostegno al cavo e, con una minore forza verso il basso, viene raggiunto un migliore equilibrio sull'impugnatura.

Balance in Ihrer Handfläche [de]

Der ERGOPLUS bietet zwei ergonomische Knickschutzsysteme; eins für wassergekühlte und eins für luftgekühlte Modelle. Das doppelte Kugelgelenk, das bei den wassergekühlten Brennern verwendet wird, sorgt für grenzenlose Bewegungsfreiheit des Brenners und hält ihn in perfekter Balance. Die luftgekühlten Versionen der ERGOPLUS Brenner verfügen über einen raffiniert gestalteten, federnden Knickschutz. Die Kunststoff-Federlösung stützt das Kabel, sorgt für ein perfektes Gleichgewicht und es wird weniger Kraft zur Bewegung des Brenners benötigt.

Équilibrée dans votre paume de main [fr]

ERGOPLUS propose deux types de support souple à la conception ergonomique ; un pour les modèles à refroidissement par eau et un pour les modèles à refroidissement par air. Grâce à la double rotule utilisée avec les torches à refroidissement par eau, les mouvements de la torche sont illimités et l'équilibre parfait de l'ensemble du produit est préservé. Les torches à refroidissement par air disposent d'un support souple à ressort en plastique intelligemment conçu. La solution à ressort en plastique soutient le câble ; ainsi, avec moins de force descendante, un meilleur équilibre est obtenu sur la poignée.

Avucunuzdaki denge [tr]

ERGOPLUS, biri su soğutmalı, diğeri hava soğutmalı modeller için olmak üzere, ergonomik olarak tasarlanmış iki farklı kabza mafsalı çözümü sunar. Su soğutmalı torçlarda kullanılan çift mafsal, torcun sınırsız hareketini sağlar ve tüm torcu mükemmel bir dengede tutar. Hava soğutmalı torç modellerinde akıllıca tasarlanmış, plastik yaylı bir kabza mafsalı bulunur. Plastik yay çözümü kabloyu destekler ve aşağı yönlü daha az kuvvet sayesinde kolda daha iyi bir denge sağlar.

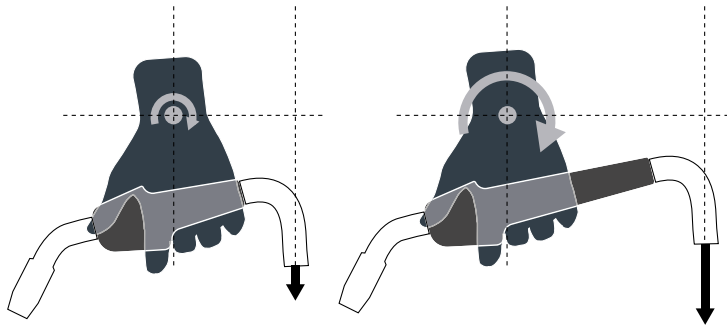

Torch handle & forces

Balance in your **palm**

ERGOPLUS provides two different ergonomic designed types of bending support; one for water-cooled and one for air-cooled models. The double ball joint used with the water-cooled torches, makes the movements of the torch limitless and keeps the whole product in perfect balance. On the air-cooled torch versions is a cleverly designed plastic spring-bending support. The plastic spring solution is giving support to the cable and with less downwards force, we reached a better balance on the handle.



Nuovo fascio cavi e cavo coassiale [it]

Sono stati rinnovati anche il fascio cavi e il cavo coassiale. I miglioramenti più importanti nei modelli raffreddati ad acqua sono la protezione garantita dal fascio cavi e la sua struttura interna. La nuova protezione ha un attrito superficiale inferiore, fattore che non può essere sottovalutata in questo componente del prodotto. Quando il saldatore si muove con la torcia di saldatura, il fascio cavi è sempre a contatto con il pavimento. Grazie alla superficie a basso attrito, il cavo non si aggancia alla pavimentazione e agli oggetti, ma si muove in modo fluido senza impigliarsi in ostacoli, angoli o bordi. Grazie ai nuovi materiali flessibili e al supporto snodo rinnovato, la torcia ERGOPLUS è facile e comoda da utilizzare in ogni situazione di saldatura.

Neues Schlauchpaket und Koaxialkabel [de]

Auch das Schlauchpaket und das Koaxialkabel wurden überarbeitet. Die wichtigsten Verbesserungen bei den wassergekühlten Modellen sind das gut geschützte Schlauchpaket und die Wasserschläuche im Inneren. Der neue Schutzschlauch hat eine geringere Oberflächenreibung. Die Bedeutung eines reibungsarmen Schutzschlauchs darf nicht unterschätzt werden. Wenn der Schweißer mit dem Schweißbrenner unterwegs ist, liegt das Schlauchpaket immer auf dem Boden. Dank seiner reibungsarmen Oberfläche klebt es nicht am Boden, sondern lässt sich mühelos bewegen. Ebenso verhindert die reibungsarme Oberfläche, dass das Schlauchpaket an Ecken oder Kanten hängen bleibt.

Nouveaux tuyaux et câble coaxial [fr]

L'ensemble tuyau et le câble coaxial ont également bénéficié d'une actualisation. Les améliorations les plus significatives apportées aux modèles à refroidissement par eau sont l'ensemble tuyau et les tuyaux d'eau internes bien protégés. Le nouveau tuyau de protection présente un frottement de surface réduit. L'importance d'un tuyau de protection à frottement réduit ne doit pas être sous-estimée. Lorsque le soudeur se déplace avec la torche de soudage, l'ensemble tuyau repose toujours sur le sol. Avec une surface à frottement réduit, il n'adhère pas au sol et se déplace de manière fluide, sans accrocher. De même, la surface à frottement réduit empêche l'ensemble tuyau de se coincer dans les angles ou les bords. Avec de nouveaux matériaux flexibles et un support souple actualisé, la torche ERGOPLUS se manipule confortablement et sans effort dans toutes les situations de soudage.

Yeni hortum paketleri ve koaksiyel kablolar [tr]

ERGOPLUS hortum paketlerinde ve koaksiyel kablolarda da yenilikler yapılmıştır. Su soğutmalı modellerdeki en önemli iyileştirmeler, yüksek korumalı hortum paketi ve su hortumlarıdır. Yeni koruyucu kılıf daha düşük yüzey sürtünmesine sahiptir. Düşük sürtünmeye sahip koruyucu kılıfın önemi göz ardı edilemez. Kaynakçı torçla hareket ederken kablo seti her zaman yerde durur. Kalos seti, düşük sürtünmeli kılıf yüzeyi sayesinde zemine yapışmaz, takılmadan sorunsuzca hareket eder. Benzer şekilde, düşük sürtünmeli yüzey, kablo setinin köşelere veya kenarlara takılmasını önler. Yeni esnek malzemeler ve yenilenmiş kabza mafsalı ile ERGOPLUS torçlar, her kaynak için zahmetsiz ve rahat bir kullanım sağlar.





New hose package and coaxial cable

The hose package and the coaxial cable have been updated as well. The most significant improvements in the water-cooled models are the well protected hose package and water hoses inside. The new protective hose has lower surface friction. The importance of a low friction protective hose cannot be underestimated. When the welder is moving with the welding torch, the hose package is always lying on the floor. With a low friction surface, it does not stick to the floor, but moves smoothly without snagging. Similarly, the low friction surface prevents the hose package from getting caught on corners or edges. With new flexible materials and updated bending support, the ERGOPLUS torch is effortless and comfortable to handle in every welding situation.

Impugnatura a pistola rimovibile [it]

Una delle caratteristiche chiave del design ergonomico della torcia ERGOPLUS è l'impugnatura a pistola rimovibile. Quando si eseguono saldature utilizzando la tradizionale impugnatura di una torcia, i muscoli della spalla e del gomito dei saldatori sono sottoposti a stress costante del carico di lavoro. Grazie alla presa dell'impugnatura a pistola, la posizione della spalla e del gomito è completamente diversa e il carico muscolare è ridotto del 25-64% a seconda della posizione di saldatura (misurazioni EMG effettuate da un'azienda specializzata indipendente - Myontec). L'impugnatura a pistola è progettata in modo da essere facilmente rimovibile e senza bisogno di attrezzi. Grazie alle sue piccole dimensioni, i saldatori possono trasportare l'impugnatura a pistola facilmente in tasca. L'impugnatura a pistola è inclusa in ogni confezione standard di vendita della torcia.

Abnehmbarer Pistolengriff [de]

Mit neuen flexiblen Materialien und einem verbesserten Knickschutz ist der ERGOPLUS-Brenner in jeder Schweißsituation unkompliziert und komfortabel zu handhaben. Eines der wichtigsten Merkmale des ergonomischen Designs des ERGOPLUS ist der abnehmbare Pistolengriff. Beim Schweißen mit einem herkömmlichen Griff sind Schulter- und Ellbogenmuskeln der Schweißer einer ständigen Belastung ausgesetzt. Mit dem Pistolengriff wird die Schulter- und Ellbogenmuskulatur völlig anders beansprucht und die Belastung ist je nach Schweißposition zwischen 25–64 % geringer (EMG-Messungen durch ein unabhängiges Fachunternehmen – Myontec). Der Brennergriff ist so konzipiert, dass er mit einem Klick und ohne Werkzeug angebracht werden kann. Aufgrund seiner geringen Größe passt der Brennergriff leicht in die Tasche des Schweißers. Der Brennergriff ist bei jedem ERGOPLUS standardmäßig enthalten.

Poignée de torche amovible [fr]

L'une des principales caractéristiques de la conception ergonomique de l'ERGOPLUS est la poignée de torche amovible. Lors de l'utilisation de la poignée traditionnelle, les muscles des épaules et des coudes des soudeurs sont soumis à la contrainte constante de la charge de travail. Avec la poignée de torche, la position des épaules et des coudes est complètement différente et la sollicitation de la force musculaire est de 25 à 64 % inférieure selon la position de soudage (mesures EMG effectuées par Myontec, entreprise spécialisée indépendante). La poignée de torche est conçue pour être facilement détachable d'un seul clic, sans nécessiter d'outil. En raison de sa taille réduite, la poignée de torche peut être facilement transportée dans la poche du soudeur. La poignée de torche est incluse dans tous les ensembles de torches standard.

Çıkarılabilir pistol Kabza [tr]

ERGOPLUS'ın ergonomik tasarımındaki en önemli özelliklerden biri, çıkarılabilir pistol kabzadır. Geleneksel kabza kullanılarak kaynak yapıldığında kaynakçının omuz ve dirsek kaslarına sürekli yük biner. Pistol kabza kullanıldığında omuz ve dirsek konumu tamamen farklıdır ve kaslara binen yük, kaynak konumuna bağlı olarak %25–64 arasında değişen oranlarda daha azdır (Bağımsız bir uzman şirket olan Myontec tarafından yapılan EMG ölçümleri). Pistol kabza, tek bir hareketle ve alet gerekmeden kolayca çıkarılabilecek şekilde tasarlanmıştır. Pistol kabza, küçük boyutu sayesinde çepte kolayca taşınabilir. Pistol kabza, tüm ERGOPLUS torçların standart kutu içeriğinde yer almaktadır.



Pistol grip handle



Detachable pistol grip handle

One of the key features in the ergonomic design of the ERGOPLUS is the detachable pistol grip handle. When welding using the traditional handle, the welders' shoulder and elbow muscles are under the constant stress of the workload. With the pistol grip handle the shoulder and elbow position is completely different and the muscle strength load is 25–64% lower depending on the welding position (EMG-measurements made by an independent specialist company- Myontec). The pistol grip is designed to be easy detachable with one click and no tools needed. Due to its small size, the pistol grip can easily be carried in the welders' pocket. The pistol grip is included in every standard torch sales package.

Connettori [it]

La nuova torcia ERGOPLUS è dotata di serie del connettore Euro. Le nuove soluzioni di tubi flessibili per connessioni di raffreddamento ad acqua di Trafimet sono uno dei risultati più importanti del lavoro di ricerca e sviluppo dell'azienda per questo componente del prodotto. Il materiale usato nei nuovi prodotti è stato realizzato con una speciale gomma EPDM, che garantisce più flessibilità e durata rispetto al materiale precedente. Anche la struttura interna della scatola posteriore è di nuova concezione per evitare l'attorcigliamento dei tubi dell'acqua.

Anschlüsse [de]

Der neue ERGOPLUS-Brenner ist serienmäßig mit einem Eurozentralanschluss ausgestattet. Die Schlauchlösungen für den Wasseranschluss von Trafimet sind das Ergebnis intensiver Forschungs- und Entwicklungsarbeit. Das Material, aus dem die Schläuche gefertigt sind, wurde auf EPDM umgestellt, das flexibler und haltbarer ist. Die innere Struktur des Anschlusses wurde ebenfalls überarbeitet, um ein Abknicken der Wasserschläuche zu verhindern.

Connecteurs [fr]

La nouvelle torche ERGOPLUS est équipée en série du connecteur Euro. Les solutions de tuyaux de raccordement d'eau de Trafimet constituent l'un des résultats les plus remarquables des travaux de R&D de l'entreprise dans le domaine des connecteurs. Le matériau utilisé dans leur conception est désormais l'EPDM, plus flexible et plus résistant que le matériau précédemment utilisé. La structure interne du boîtier arrière a également été redéfinie pour éviter tout écrasement dans les tuyaux d'eau.

Bağlantılar [tr]

Yeni ERGOPLUS torçlarda standart olarak Euro tip bağlantı bulunur. Trafimet'in sunduğu su hortumu bağlantı çözümleri, şirketin bu alandaki Ar-Ge çalışmalarının en dikkat çekici sonuçlarından biridir. Hortum tasarımlarında bir önceki hortum modellerinde yer alan malzemenin daha esnek ve dayanıklı olan EPDM kullanılmaktadır. Dip kovan takımının iç yapısı da su hortumlarında herhangi bir bükülmenin önlenmesi için yeniden tasarlanmıştır.





The connectors

The new ERGOPLUS torch is equipped with the euro connector as standard.

Trafimet's water connector hose solutions are one of the most remarkable results of the company's R&D work in the field of connectors.

The material used in its designs has been updated to EPDM, which is more flexible and durable than previous hose material. The inner structure of the rear box has also been redesigned to avoid any kinking in the water hoses.

Consumabili [it]

La nuova torcia ERGOPLUS è compatibile con i consumabili delle versioni precedenti. L'ERGOPLUS ha quattro diverse parti consumabili: l'ugello del gas, la punta di contatto, il diffusore del gas e il supporto della punta guidafile. L'ugello gas delle ERGOPLUS (26-36-400-500-555) è compatibile con il modello Trafimet "Quick-Release"

Verschleißteile [de]

Der neue ERGOPLUS ist mit den Verschleißteilen der alten Version kompatibel. Es gibt vier verschiedene Verschleißteile am ERGOPLUS: Gasdüse, Stromdüse, Gasverteiler und Düsenstock. Die Gasdüse des ERGOPLUS (26-36-400-500-555) ist auch mit dem Trafimet „Schnellverschluss“-Modell kompatibel.

Consommables [fr]

La nouvelle torche ERGOPLUS est compatible avec les consommables des anciennes versions. ERGOPLUS comprend quatre consommables ; buse de gaz, tube contact, diffuseur de gaz et support de tube contact. La buse de gaz de l'ERGOPLUS (26-36-400-500-555) est également compatible avec le modèle « Quick Release » de Trafimet.

Sarf malzemeleri [tr]

Yeni ERGOPLUS, bir önceki model sarf malzemeleriyle uyumludur. ERGOPLUS torçlarda genel itibari ile dört farklı sarf malzemesi bulunur. Bunlar; gaz nozulu, kontak meme, gaz difüzörü ve kontak meme tutucudur. ERGOPLUS (26-36-400-500-555) gaz nozulu Trafimet "Quick Release" modeli ile de uyumludur.

Quick-Release**Quick-Release****4 consumable parts [en]**

Gas nozzle
contact tip
gas diffuser
contact tip holder

4 parti consumabili [it]

ugello del gas
punta di contatto
diffusore del gas
supporto punta guidafile

4 Verschleißteile [de]

Gasdüse
Stromdüse
Gasverteiler
Düsenstock

4 Consommables [fr]

buse de gaz
tube contact
diffuseur de gaz
support

4 sarf malzemesi [tr]

gaz nozulu kontak meme
gaz difüzörü kontak meme tutucu



Consumables

New ERGOPLUS is compatible with old version consumables. There are four different consumable parts on the ERGOPLUS; Gas nozzle, contact tip, gas diffuser, and contact tip holder. The gas nozzle of the ERGOPLUS (26-36-400-500-555) is also compatible with Trafimet "Quick Release" model.

Sistema di raffreddamento implementato [it]

Anche la bassa temperatura della lancia è una parte importante della torcia di saldatura. Le lance della torcia ERGOPLUS raffreddate ad aria e ad acqua sono ora più fredde che mai. Una lancia più fredda aumenta la durata dei consumabili. Quando si eseguono saldature continue a 350 A, il calore della punta di contatto ERGOPLUS 500 non supera i 170 °C, il 30% inferiore rispetto alle precedenti torce raffreddate ad acqua.

Refroidissement plus efficace [fr]

La basse température de la tête de torche est également un élément important de la torche de soudage. Les têtes de torche ERGOPLUS à refroidissement par air et par eau sont désormais plus froides que jamais. Avec une structure plus froide, le taux d'utilisation des consommables est réduit. Lors d'opérations de soudage à 350 A en continu, la température du tube contact de l'ERGOPLUS 500 ne dépasse pas 170 °C - Une température inférieure d'au moins 30 % par rapport aux précédentes torches à refroidissement par eau.

Bessere Kühlung [de]

Die Kühlung ist ebenfalls ein wichtiger Bestandteil des Schweißbrenners. Sowohl luftgekühlte als auch wassergekühlte ERGOPLUS-Brenner bleiben jetzt kühler als je zuvor. Mit einer kühleren Struktur wird der Verbrauch von Verschleißteilen reduziert. Beim kontinuierlichen Schweißen mit 350 A steigt die Wärme der ERGOPLUS 500 Stromdüse nicht über 170 °C – mindestens 30 % kühler als frühere wassergekühlte Brenner.

Daha da soğuk [tr]

Düşük torç boynu sıcaklığı da kaynak torçlarında olması gereken önemli bir özelliktir. Hem hava soğutmalı hem de su soğutmalı ERGOPLUS torç boyunları, artık her zamankinden daha soğuk. Daha soğuk yapı sayesinde; sarf malzemelerinin daha düşük oranlarda tüketilmesi sağlanmaktadır. ERGOPLUS 500 modeli ile 350A seviyesinde uzun süreli olarak yapılan kaynak uygulamasında kontak meme ısısı 170°C'nin üzerine çıkmamaktadır. Bu, önceki su soğutmalı torçlara kıyasla %30 daha düşük sıcaklık anlamına gelmektedir.

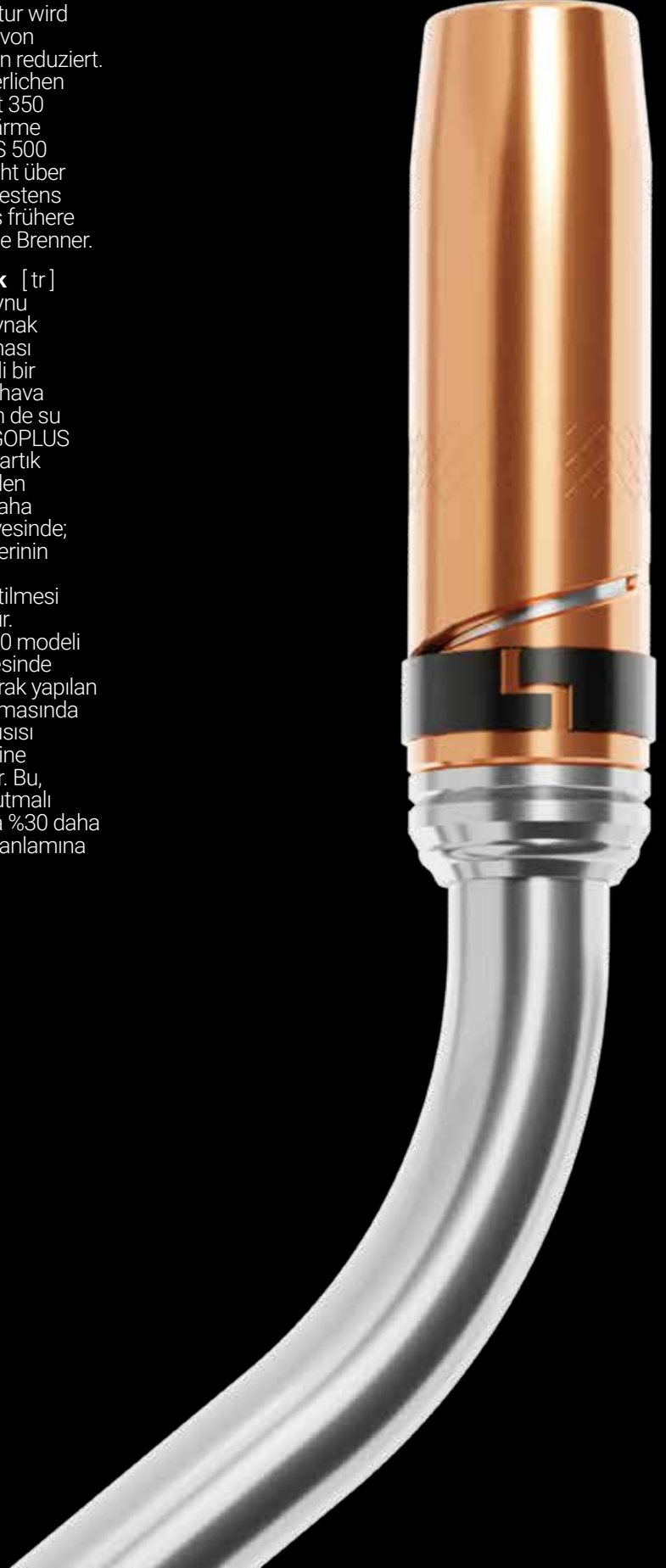

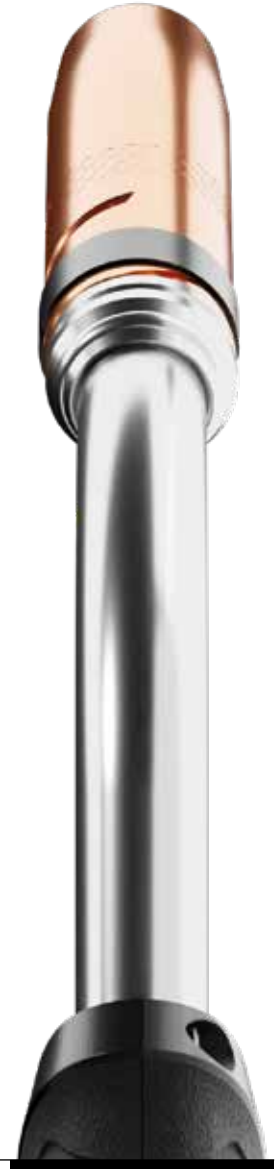

Even cooler

The low torch head temperature is also an important part of the welding torch. Both air-cooled and water-cooled ERGOPLUS torch heads are now cooler than ever before. With a cooler structure, the consumption rate of consumables is reduced. On continuous 350A welding ERGOPLUS 500 contact tip heat doesn't rise over 170 C° - At least 30% cooler than previous water-cooled torches.



Pulsante micro switch [it]

La torcia ERGOPLUS è dotata di un pulsante a microinterruttore sigillato. Più affidabile della tradizionale soluzione meccanica che hanno un contatto aperto esposto a sporco, polvere e umidità. Il microinterruttore ha un livello di protezione pari a IP67. Trattandosi di un livello molto elevato rispetto agli altri componenti elettrici dei sistemi di saldatura, garantisce un utilizzo affidabile a lungo termine.

Versiegelter Mikroschalter [de]

Der ERGOPLUS Brenntaster ist mit einem geschützten Mikroschalter ausgestattet. Dieser ist zuverlässiger als die bisherige, mechanische Lösung, bei der ein offener Kontakt Schmutz, Staub und Feuchtigkeit ausgesetzt ist. Der Mikroschalter ist nach IP67 geschützt und gewährleistet eine lange und zuverlässige Nutzungsdauer.

Microswitch isolé pour la gâchette [fr]

L'ERGOPLUS a été équipée d'une gâchette à micro-interrupteur scellé. Elle est plus fiable que la solution mécanique alternative, dotée d'un contact ouvert exposé à la saleté, à la poussière et à l'humidité. Le micro-interrupteur bénéficie de l'indice de protection IP67, une norme bien plus élevée que celle des autres composants électriques des systèmes de soudage, garantissant une longue durée de vie et une utilisation fiable.

İzolasyonlu mikro-switch tetik [tr]

ERGOPLUS, izolasyonlu bir mikro-switch tetik ile donatılmıştır. Bu çözüm; kir, toz ve neme maruz kalabilen açık temaslı alternatif mekanik çözümden daha güvenilirdir. Mikro-switch, kaynak sistemlerindeki diğer elektrikli bileşenlerden çok daha yüksek bir standart olan IP67 dereceli korumaya sahiptir ve uzun, güvenilir kullanım sağlar.

Sealed microswitch trigger

The ERGOPLUS has been fitted with a sealed microswitch trigger. It is more reliable than the alternative mechanical solution which has an open contact exposed to dirt, dust, and humidity. The microswitch is IP67 protected, a much higher standard than other electrical components on welding systems, ensuring a long lifetime of reliable use.

Trigger

A close-up, side-profile view of a welding torch trigger. The trigger is dark grey or black with a prominent blue-tinted microswitch in the center. The background is a solid, deep blue. A thin white line extends from the text 'Trigger' to the blue-tinted switch.

ERGOPLUS 15

CE EN60974-7









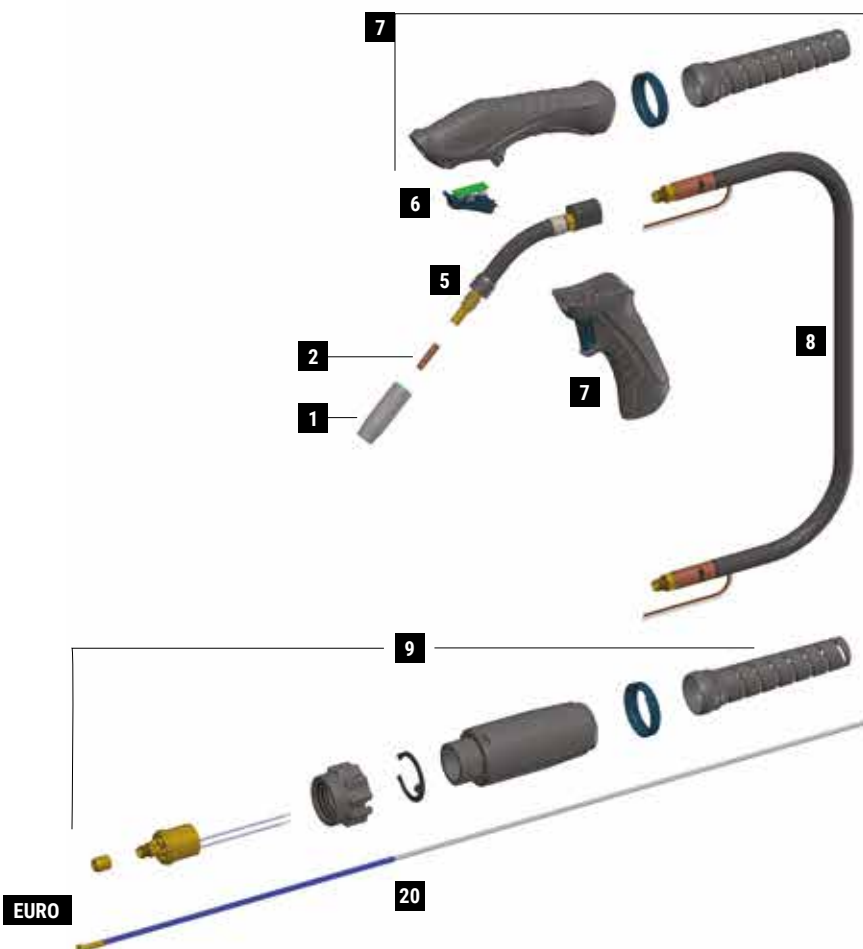





CODE	↔			
MA4200-030	3 m	10'		1
MA4200-040	4 m	12'		1
MA4200-050	5 m	16.4'		1









CODE	↔			
MA4200X030	3 m	10'		25
MA4200X040	4 m	12'		25
MA4200X050	5 m	16.4'		25

TECHNICAL DATA		
	ERGOPLUS 15	
	0,65 kg	1.43 lb
V PEAK	113	
	0,6 ÷ 1,0 mm	.023" ÷ 1/16"
X 60%	180A CO2 - 150A Mix	



	CODE			Ø				REF	
1	MC0017		nozzle	9,5 mm	3/8"	53 mm	2-1/16"	145.0123	10
1	MC0018		nozzle	12 mm	1/2"	53 mm	2-1/16"	145.0075	10
1	MC0019		nozzle	16 mm	5/8"	53 mm	2-1/16"	145.0041	10
1	MC0020		nozzle	16 mm	5/8"	61,5 mm	2"-13/32	145.0168	10
1	MC0266		nozzle	13 mm	1/2"	53 mm	2-1/16"	145.0143	10
2	MD0008-06		M6 - Cu	0,6 mm	.023"	25 mm	31/32"	140.0008	20
2	MD0008-08		M6 - Cu	0,8 mm	.030"	25 mm	31/32"	140.0059	20
2	MD0008-09		M6 - Cu	0,9 mm	.035"	25 mm	31/32"	140.0177	20
2	MD0008-10		M6 - Cu	1,0 mm	.040"	25 mm	31/32"	140.0253	20
2	MD0008-12		M6 - Cu	1,2 mm	.045"	25 mm	31/32"	140.0387	20
20	GM0500		blue steel liner	0,6 ÷ 0,9 mm	.023" ÷ .035"	3 m	10'	124.0011	1
20	GM0501		blue steel liner	0,6 ÷ 0,9 mm	.023" ÷ .035"	4 m	12'	124.0012	1
20	GM0502		blue steel liner	0,6 ÷ 0,9 mm	.023" ÷ .035"	5 m	16.4'	124.0015	1

	CODE			
5	BW0562		plastic body	10
5	EA0303		spring	10
5	FB0112		hexagonal fitting	10
5	FB0117		diffuser	10
5	MF1515		Ergoplus 15 torch head	1
6	MT0563		trigger kit	1
7	MT0562		handle kit	1
7	MT0566		pistol grip	1
8	MH0816-030		coaxial cable - 3 m / 10'	1

	CODE			
8	MH0816-040		coaxial cable - 4 m / 12'	1
8	MH0816-050		coaxial cable - 5 m / 16.4'	1
9	AR0070		EURO connector - air	1
9	BW0018		Euro nut plastic	10
9	FA0026		liner nut M10x1	10
9	MT0565		Back box kit EURO	1

ERGOPLUS 24

CE EN60974-7









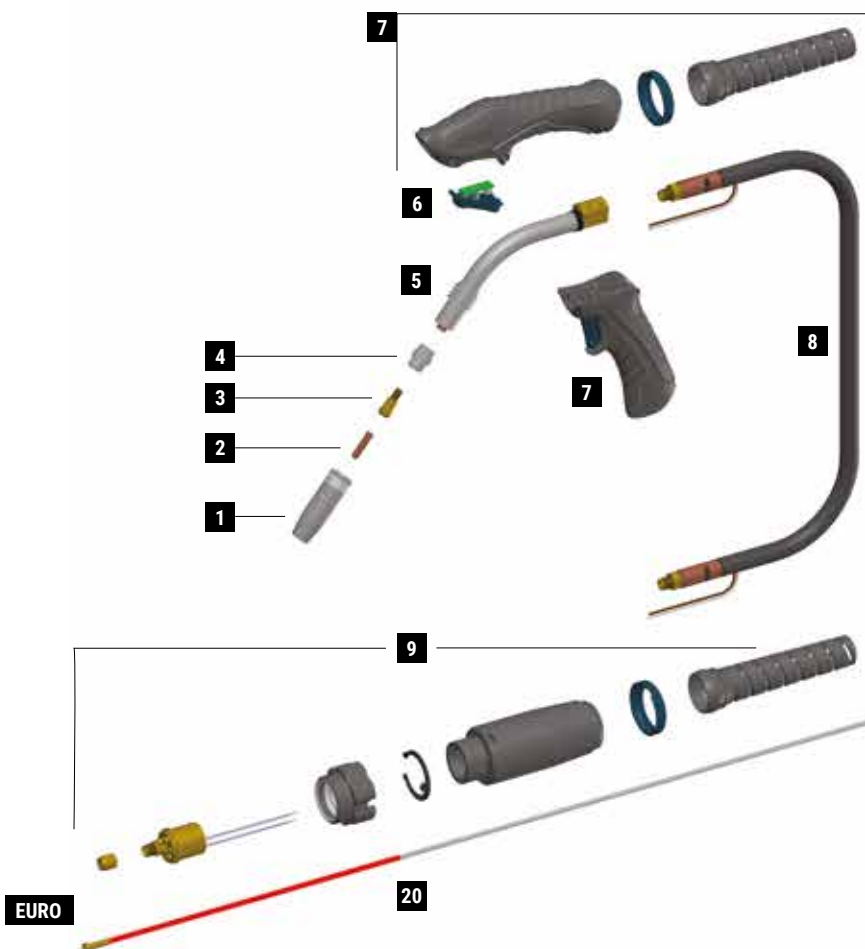

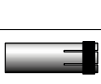
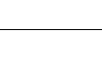







CODE	↔			
MA4201-030	3 m	10'		1
MA4201-040	4 m	12'		1
MA4201-050	5 m	16.4'		1







CODE	↔			
MA4201X030	3 m	10'		25
MA4201X040	4 m	12'		25
MA4201X050	5 m	16.4'		25

TECHNICAL DATA		
	ERGOPLUS 24	
	0,9 kg	1.98 lb
V PEAK	113	
	0,6 ÷ 1,2 mm	.30" - .045"
X 60%	250A CO2 - 220A Mix	

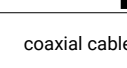

	CODE			Ø				REF	
1	MC0300		nozzle	17 mm	21/32"	63,5 mm	2-1/2"	145.0062	10
1	MC0301		nozzle	12,5 mm	1/2"	63,5 mm	2-1/2"	145.0080	10
1	MC0302		nozzle	10 mm	13/32"	63,5 mm	2-1/2"	145.0128	10
1	MC0303		nozzle	17 mm	21/32"	68 mm	2-11/16"	145.0174	10
2	MD0008-06		M6 - Cu	0,6 mm	.023"	25 mm	31/32"	140.0008	20
2	MD0008-08		M6 - Cu	0,8 mm	.030"	25 mm	31/32"	140.0059	20
2	MD0008-09		M6 - Cu	0,9 mm	.035"	25 mm	31/32"	140.0177	20
2	MD0008-10		M6 - Cu	1,0 mm	.040"	25 mm	31/32"	140.0253	20
2	MD0008-12		M6 - Cu	1,2 mm	.045"	25 mm	31/32"	140.0387	20
3	MD0138-00		M6 - brass			26 mm	1" 1/32	142.0003	20
4	ME0084		plastic			20 mm	25/32"	012.0183	10
4	ME0086		silicon			20 mm	25/32"	-	10
4	ME0484		plastic compound high tech			20 mm	25/32"	-	10
4	ME0584		ceramic			20 mm	25/32"	-	10
20	GM0510		red steel liner	1,0 ÷ 1,2 mm	.040" ÷ .045"	3 m	10'	124.0026	1
20	GM0511		red steel liner	1,0 ÷ 1,2 mm	.040" ÷ .045"	4 m	12'	124.0031	1
20	GM0512		red steel liner	1,0 ÷ 1,2 mm	.040" ÷ .045"	5 m	16.4'	124.0035	1

	CODE			
5	MF1516		Ergoplus 24 torch head	1
6	MT0563		trigger kit	1
7	MT0562		handle kit	1
7	MT0566		pistol grip	1
8	MH0817-030		coaxial cable - 3 m / 10'	1
8	MH0817-040		coaxial cable - 4 m / 12'	1

	CODE			
8	MH0817-050		coaxial cable - 5 m / 16.4'	1
9	AR0070		EURO connector - air	1
9	BW0020		metal EURO nut	10
9	FA0026		liner nut M10x1	10
9	MT0565		Back box kit EURO	1

STANDARD

ERGOPLUS 25

CE EN60974-7









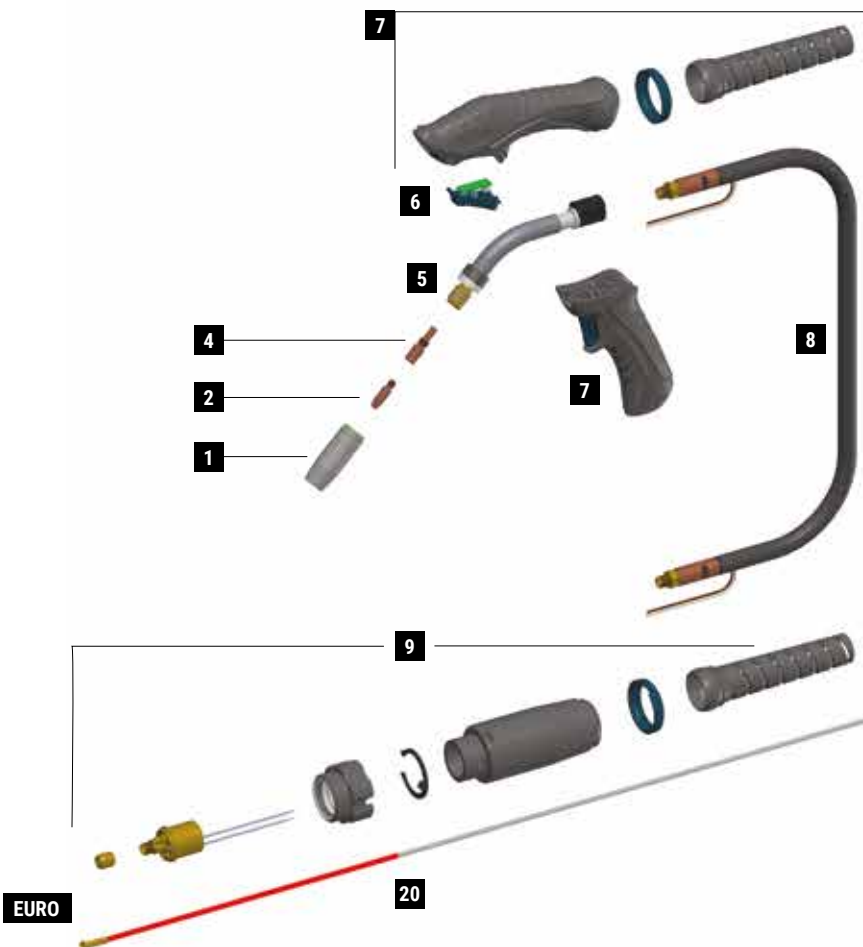

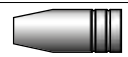



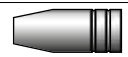

CODE	↔			
MA4202-030	3 m	10'		1
MA4202-040	4 m	12'		1
MA4202-050	5 m	16.4'		1

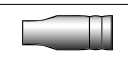
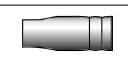

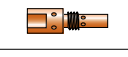
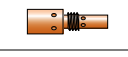
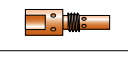
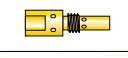





CODE	↔			
MA4202X030	3 m	10'		25
MA4202X040	4 m	12'		25
MA4202X050	5 m	16.4'		25

TECHNICAL DATA		
	ERGOPLUS 25	
	0,9 kg	1.98 lb
V PEAK	113	
	0,8 ÷ 1,2 mm	.030" ÷ .045"
X 60%	230A CO2 - 220A Mix	



	CODE			Ø				REF	
1	MC0022		nozzle	11,5 mm	7/16"	57 mm	2"-1/4	145.0124	10
1	MC0023		nozzle	15 mm	19/32"	57 mm	2"-1/4	145.0076	10
1	MC0024		nozzle	18 mm	23/32"	57 mm	2"-1/4	145.0042	10
1	MC0025		nozzle	20 mm	25/32"	66,5 mm	2-5/8"	145.0169	10
1	MC0265		nozzle	11 mm	7/16"	57 mm	2"-1/4	-	10
1	MC0267		nozzle	14 mm	9/16"	57 mm	2"-1/4	-	10
2	MD0009-06		M6 - Cu	0,6 mm	.023"	28 mm	1"-3/32	140.0005	20
2	MD0009-08		M6 - Cu	0,8 mm	.030"	28 mm	1"-3/32	140.0051	20
2	MD0009-09		M6 - Cu	0,9 mm	.035"	28 mm	1"-3/32	140.0169	20
2	MD0009-10		M6 - Cu	1,0 mm	.040"	28 mm	1"-3/32	140.0242	20
2	MD0009-12		M6 - Cu	1,2 mm	.045"	28 mm	1"-3/32	140.0379	20
2	MD0009-14		M6 - Cu	1,4 mm	.052"	28 mm	1"-3/32	-	20
2	MD0009-16		M6 - Cu	1,6 mm	1/16"	28 mm	1"-3/32	140.0555	20
4	ME0016		M6 - copper			35 mm	1"-3/8	142.0001	10
4	ME0040		M8 - copper			35 mm	1"-3/8	-	10
4	ME0060		M6 - copper			37 mm	1"-15/32	-	10
4	ME0216		M6 - brass			35 mm	1"-3/8	-	10
20	GM0510		red steel liner	1,0 ÷ 1,2 mm	.040" ÷ .045"	3 m	10'	124.0026	1
20	GM0511		red steel liner	1,0 ÷ 1,2 mm	.040" ÷ .045"	4 m	12'	124.0031	1
20	GM0512		red steel liner	1,0 ÷ 1,2 mm	.040" ÷ .045"	5 m	16.4'	124.0035	1

	CODE			
5	BW0562		plastic body	10
5	EA0304		spring	10
5	MF1517		Ergoplus 25 torch head	1
6	MT0563		trigger kit	1
7	MT0562		handle kit	1
7	MT0566		pistol grip	1
8	MH0817-030		coaxial cable - 3 m / 10'	1
8	MH0817-040		coaxial cable - 4 m / 12'	1

	CODE			
8	MH0817-050		coaxial cable - 5 m / 16.4'	1
9	AR0070		EURO connector - air	1
9	BW0020		metal EURO nut	10
9	FA0026		liner nut M10x1	10
9	MT0565		Back box kit EURO	1

STANDARD

ERGOPLUS 26

CE EN60974-7









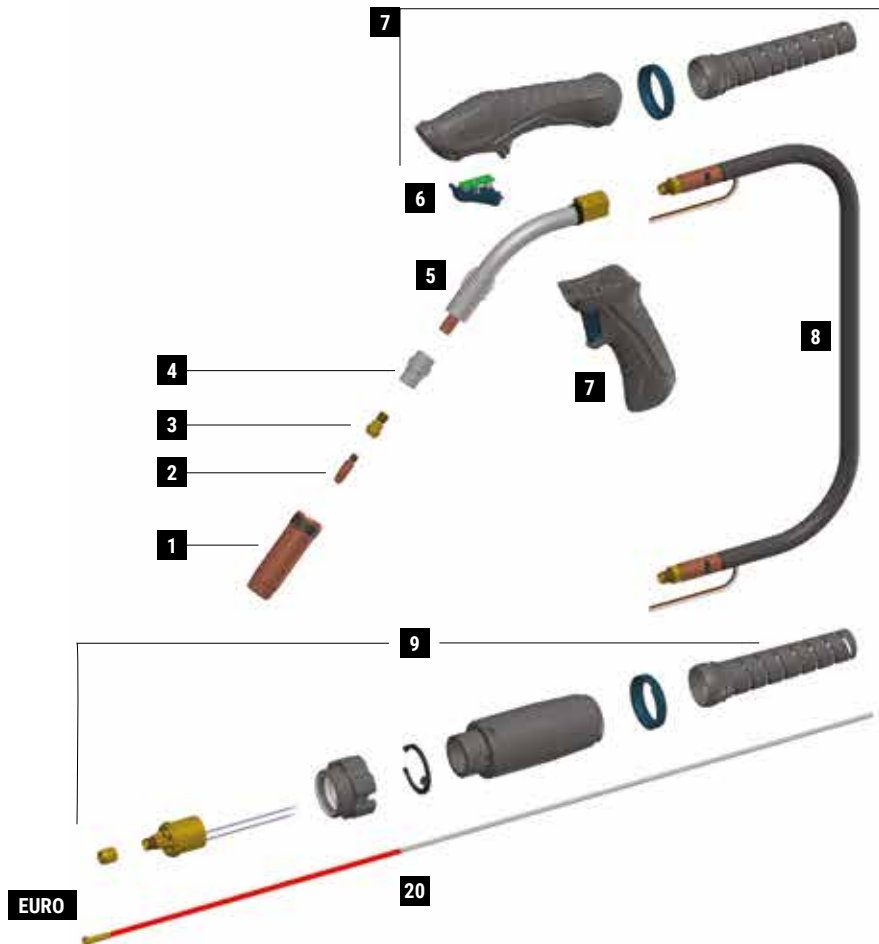





















CODE	↔			
MA4203-030	3 m	10'		1
MA4203-040	4 m	12'		1
MA4203-050	5 m	16.4'		1









CODE	↔			
MA4203X030	3 m	10'		25
MA4203X040	4 m	12'		25
MA4203X050	5 m	16.4'		25

TECHNICAL DATA		
ERGOPLUS 26		
	1,25 kg	2.76 lb
V PEAK	113	
	0,8 ÷ 1,2 mm	.030" ÷ .45"
X 60%	290A CO2 - 260A Mix	



	CODE			Ø				REF	
1	MC0268		nozzle - 2,5 mm thickness	16 mm	5/8"	76 mm	3"	145.0085	10
1	MC0276		nozzle - 2 mm thickness	16 mm	5/8"	76 mm	3"	145.0085	10
1	MC0290		nozzle - 2,5 mm thickness	14 mm	9/16"	76 mm	3"	145.0132	10
1	MC0291		nozzle - 2,5 mm thickness	20 mm	25/32"	76 mm	3"	145.0051	10
1	MC0292		nozzle - 2,5 mm thickness	15 mm	19/32"	76 mm	3"	-	10
1	MC0293		nozzle - 2,5 mm thickness	20 mm	25/32"	82 mm	3-7/32"	145.0179	10
1	MC0340		heavy duty nozzle - 3 mm thickness	16 mm	5/8"	76 mm	3"	-	10
1	MC0568		quick release nozzle - 2,5 mm thickness	16 mm	5/8"	76 mm	3"	-	10
1	MC0576		quick release light nozzle - 2 mm thickness	16 mm	5/8"	76 mm	3"	-	10
2	MD0009-06		M6 - Cu	0,6 mm	.023"	28 mm	1"-3/32	140.0005	20
2	MD0009-08		M6 - Cu	0,8 mm	.030"	28 mm	1"-3/32	140.0051	20
2	MD0009-09		M6 - Cu	0,9 mm	.035"	28 mm	1"-3/32	140.0169	20
2	MD0009-10		M6 - Cu	1,0 mm	.040"	28 mm	1"-3/32	140.0242	20
2	MD0009-12		M6 - Cu	1,2 mm	.045"	28 mm	1"-3/32	140.0379	20
2	MD0009-14		M6 - Cu	1,4 mm	.052"	28 mm	1"-3/32	-	20
2	MD0009-16		M6 - Cu	1,6 mm	1/16"	28 mm	1"-3/32	140.0555	20
3	MD0061-00		M6 - brass			22 mm	7/8"	142.0007	20
3	MD0062-00		M8 - brass			22 mm	7/8"	142.0082	20
4	ME0085		plastic			29 mm	1"-5/32	018.0116	10
4	ME0485		plastic			29 mm	1"-5/32	-	10
4	ME0585		ceramic			29 mm	1"-5/32	018.0141	10
20	GM0510		red steel liner	1,0 ÷ 1,2 mm	.040" ÷ .045"	3 m	10'	124.0026	1
20	GM0511		red steel liner	1,0 ÷ 1,2 mm	.040" ÷ .045"	4 m	12'	124.0031	1
20	GM0512		red steel liner	1,0 ÷ 1,2 mm	.040" ÷ .045"	5 m	16.4'	124.0035	1

	CODE			
5	MF1518		Ergoplus 26 torch head	1
6	MT0563		trigger kit	1
7	MT0562		handle kit	1
8	MT0566		pistol grip	1
8	MH0818-030		coaxial cable - 3 m / 10'	1
8	MH0818-040		coaxial cable - 4 m / 12'	1

	CODE			
8	MH0818-050		coaxial cable - 5 m / 16.4'	1
9	AR0070		EURO connector - air	1
9	BW0020		metal EURO nut	10
9	FA0026		liner nut M10x1	10
9	MT0565		Back box kit EURO	1

STANDARD

ERGOPLUS 36

CE EN60974-7









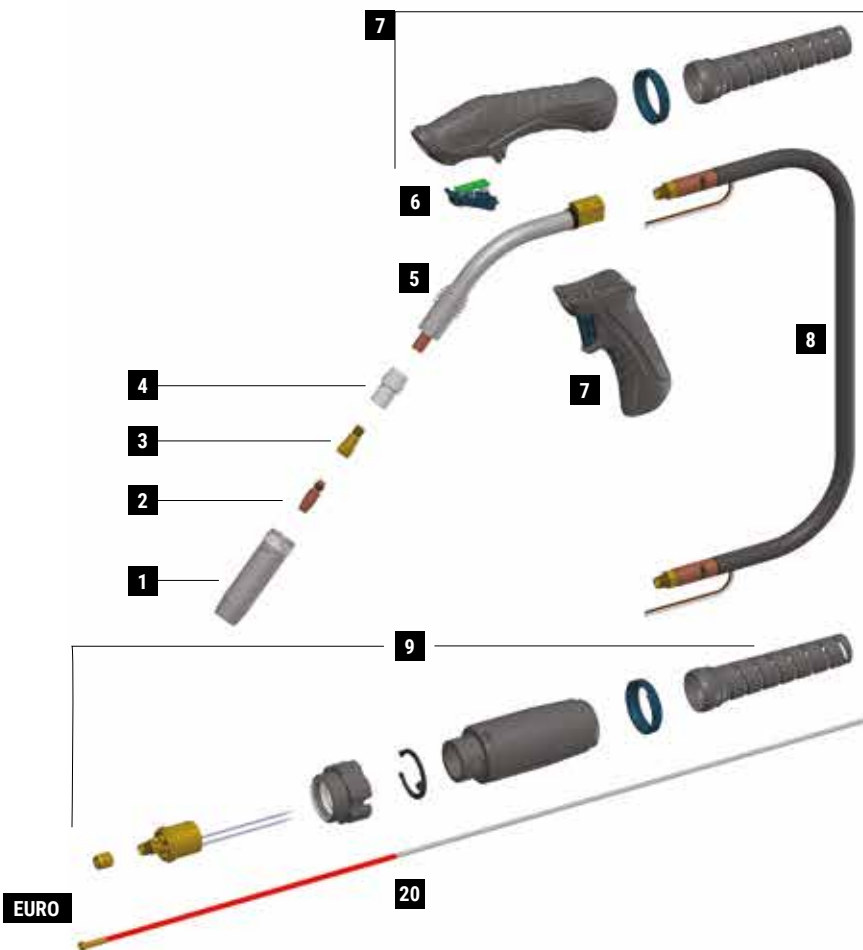

















CODE	↔			
MA4204-030	3 m	10'		1
MA4204-040	4 m	12'		1
MA4204-050	5 m	16.4'		1

CODE	↔			
MA4204X030	3 m	10'		25
MA4204X040	4 m	12'		25
MA4204X050	5 m	16.4'		20

TECHNICAL DATA		
ERGOPLUS 36		
	1,4 kg	3.09 lb
	113	
V PEAK	113	
	0,6 ÷ 1,6 mm	.023" ÷ 1/16"
X 60%	330A CO2 - 300A Mix	



	CODE			Ø				REF	
1	MC0110		nozzle - 2,5 mm thickness	20 mm	25/32"	90 mm	3"-17/32	145.0172	10
1	MC0026		nozzle - 2,5 mm thickness	12 mm	1/2"	84 mm	3"-5/16	145.0126	10
1	MC0027		nozzle - 2,5 mm thickness	16 mm	5/8"	84 mm	3"-5/16	145.0078	10
1	MC0028		nozzle - 2,5 mm thickness	19 mm	3/4"	84 mm	3"-5/16	145.0045	10
1	MC0109		nozzle - 2,5 mm thickness	17 mm	21/32"	84 mm	3"-5/16	-	10
1	MC0440		nozzle - 2 mm thickness	16 mm	5/8"	84 mm	3"-5/16	-	10
1	MC0527		quick release nozzle - 2,5 mm thickness	16 mm	5/8"	84 mm	3"-5/16	-	10
1	MC0540		quick release light nozzle - 2 mm thickness	16 mm	5/8"	84 mm	3"-5/16	-	10
2	MD0005-78		M8 - CuCrZr	0,8 mm	.030"	30 mm	1"-3/16	-	20
2	MD0005-80		M8 - CuCrZr	1,0 mm	.040"	30 mm	1"-3/16	140.0316	20
2	MD0005-82		M8 - CuCrZr	1,2 mm	.045"	30 mm	1"-3/16	140.0445	20
2	MD0005-84		M8 - CuCrZr	1,4 mm	.052"	30 mm	1"-3/16	140.0536	20
2	MD0005-86		M8 - CuCrZr	1,6 mm	1/16"	30 mm	1"-3/16	140.0590	20
2	MD0005-90		M8 - CuCrZr	2,0 mm	5/64"	30 mm	1"-3/16	140.0656	20
2	MD0005-94		M8 - CuCrZr	2,4 mm	3/32"	30 mm	1"-3/16	-	20
3	MD0063-00			M6 - brass			28 mm	1"-3/32	142.0005
3	MD0064-00		M8 - brass			28 mm	1"-3/32	142.0020	20
3	MD0131-00		M6 - brass			32 mm	1"-1/4	142.0011	20
3	MD0132-00		M8 - brass			32 mm	1"-1/4	142.0024	20
4	ME0017		plastic			32,8 mm	1"-9/32	014.0261	10
4	ME0041		plastic			32,8 mm	1"-9/32	014.0021	10
4	ME0417		high-tech plastic			32,8 mm	1"-9/32	-	10
4	ME0517		ceramic			32,8 mm	1"-9/32	014.0023	10
20	GM0510		red steel liner	1,0 ÷ 1,2 mm	.040" ÷ .045"	3 m	10'	124.0026	1
20	GM0511		red steel liner	1,0 ÷ 1,2 mm	.040" ÷ .045"	4 m	12'	124.0031	1
20	GM0512		red steel liner	1,0 ÷ 1,2 mm	.040" ÷ .045"	5 m	16.4'	124.0035	1

	CODE			
5	MF1519		Ergoplus 36 torch head	1
6	MT0563		trigger kit	1
7	MT0562		handle kit	1
7	MT0566		pistol grip	1
8	MH0819-030		coaxial cable - 3 m / 10'	1
8	MH0819-040		coaxial cable - 4 m / 12'	1
8	MH0819-050		coaxial cable - 5 m / 16.4'	1

	CODE			
9	AR0070		EURO connector - air	1
9	BW0020		metal EURO nut	10
9	FA0026		liner nut M10x1	10
9	MT0565		Back box kit EURO	1

STANDARD

ERGOPLUS 240

CE EN60974-7



CODE	↔			
MB2600-030	3 m	10'		1
MB2600-040	4 m	12'		1
MB2600-050	5 m	16.4'		1

TECHNICAL DATA		
	ERGOPLUS 240	
	1,1 kg	2.43 lb
V PEAK	113	
	0,8 ÷ 1,2 mm	.030" ÷ .045"
X 100%	300A CO2 - 270A Mix	
	2÷4 bar	
	1,6 l/min	

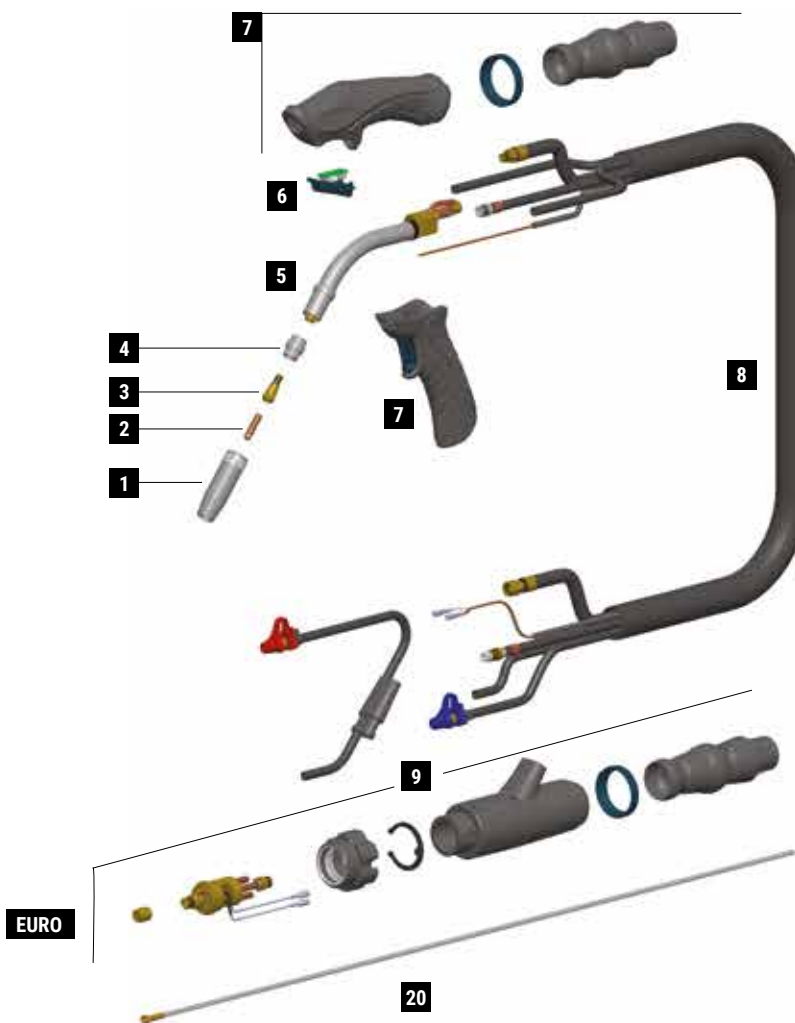

	CODE			Ø		↔	REF		
1	MC0300		nozzle	17 mm	21/32"	63,5 mm	2-1/2"	145.0062	10
1	MC0301		nozzle	12,5 mm	1/2"	63,5 mm	2-1/2"	145.0080	10
1	MC0302		nozzle	10 mm	13/32"	63,5 mm	2-1/2"	145.0128	10
1	MC0303		nozzle	17 mm	21/32"	68 mm	2-11/16"	145.0174	10
2	MD0008-06		M6 - Cu	0,6 mm	.023"	25 mm	31/32"	140.0008	20
2	MD0008-08		M6 - Cu	0,8 mm	.030"	25 mm	31/32"	140.0059	20
2	MD0008-09		M6 - Cu	0,9 mm	.035"	25 mm	31/32"	140.0177	20
2	MD0008-10		M6 - Cu	1,0 mm	.040"	25 mm	31/32"	140.0253	20
2	MD0008-12		M6 - Cu	1,2 mm	.045"	25 mm	31/32"	140.0387	20
3	MD0138-00		M6 - brass			26 mm	1" 1/32	142.0003	20
4	ME0084		plastic			20 mm	25/32"	012.0183	10
4	ME0086		silicon			20 mm	25/32"	-	10
4	ME0484		plastic compound high tech			20 mm	25/32"	-	10
4	ME0584		ceramic			20 mm	25/32"	-	10
20	GM0526		uncoated steel liner	1,0 ÷ 1,2 mm	.040" ÷ .045"	3 m	10'		1
20	GM0527		uncoated steel liner	1,0 ÷ 1,2 mm	.040" ÷ .045"	4 m	12'		1
20	GM0528		uncoated steel liner	1,0 ÷ 1,2 mm	.040" ÷ .045"	5 m	16.4'		1

	CODE			
5	MG0284		Ergoplus 240 torch head	1
6	MT0563		trigger kit	1
7	MT0560		handle kit	1
7	MT0566		pistol grip	1
8	MN2014-030		cable assembly - 3 m / 10'	1
8	MN2014-040		cable assembly - 4 m / 12'	1

	CODE			
8	MN2014-050		cable assembly - 5 m / 16.4'	1
8	AR0052		EURO connector	1
9	BW0020		metal EURO nut	10
9	FA0026		liner nut M10x1	10
9	MT0564		Back box kit	1

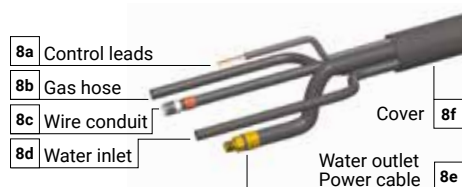

	CODE	↔
8a	BX1421-030	3 m / 10'
8b	QB0231-030	3 m / 10'
8c	QB0230-030	3 m / 10'
8d	QB0232-030	3 m / 10'
8e	QA0030-030	3 m / 10'
8f	MQ0125-030	3 m / 10'

	CODE	↔
8a	BX1421-040	4 m / 12'
8b	QB0231-040	4 m / 12'
8c	QB0230-040	4 m / 12'
8d	QB0232-040	4 m / 12'
8e	QA0030-040	4 m / 12'
8f	MQ0125-040	4 m / 12'

	CODE	↔
8a	BX1421-050	5 m / 16.4'
8b	QB0231-050	5 m / 16.4'
8c	QB0230-050	5 m / 16.4'
8d	QB0232-050	5 m / 16.4'
8e	QA0030-050	5 m / 16.4'
8f	MQ0125-050	5 m / 16.4'

STANDARD

ERGOPLUS 400

CE EN60974-7



CODE	↔			
MB2601-030	3 m	10'		1
MB2601-040	4 m	12'		1
MB2601-050	5 m	16.4'		1

TECHNICAL DATA	
	ERGOPLUS 400
	1,25 kg 2.76 lb
	113
	1,0 ÷ 1,6 mm .040" ÷ 1/16"
	400A CO2 - 350A Mix
	2÷4 bar
	1,6 l/min

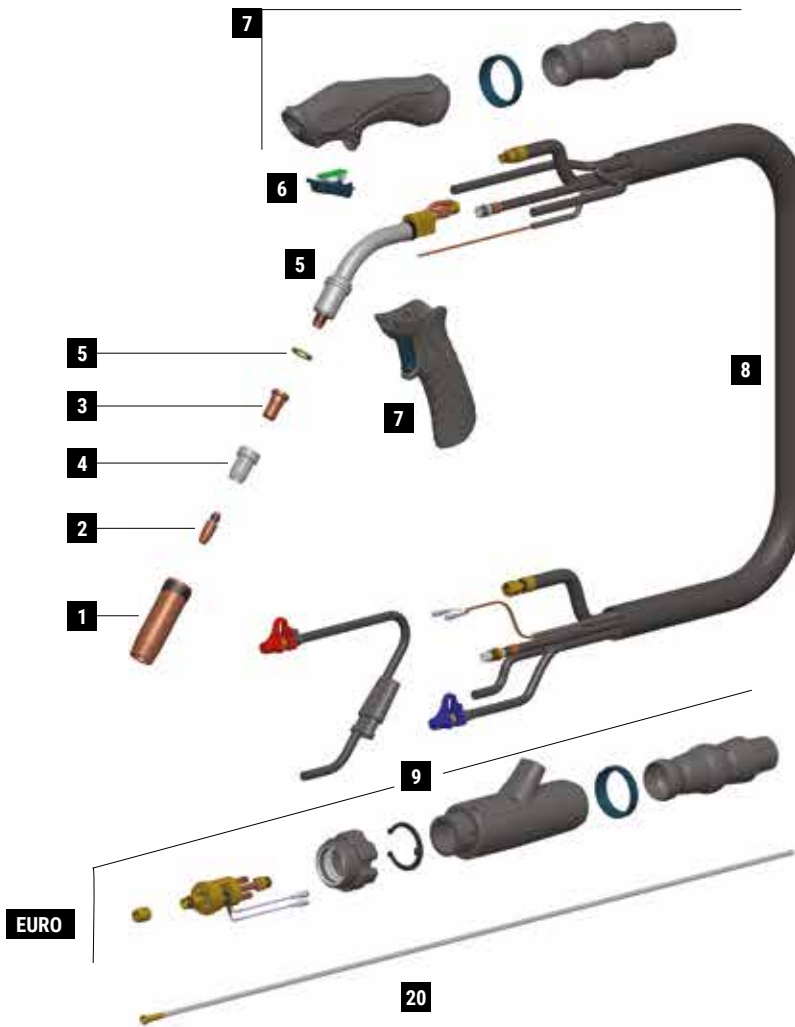

	CODE			Ø		↔	REF		
1	MC0268		nozzle - 2,5 mm thickness	16 mm	5/8"	76 mm	3"	145.0085	10
1	MC0276		nozzle - 2 mm thickness	16 mm	5/8"	76 mm	3"	145.0085	10
1	MC0290		nozzle - 2,5 mm thickness	14 mm	9/16"	76 mm	3"	145.0132	10
1	MC0291		nozzle - 2,5 mm thickness	20 mm	25/32"	76 mm	3"	145.0051	10
1	MC0292		nozzle - 2,5 mm thickness	15 mm	19/32"	76 mm	3"	-	10
1	MC0293		nozzle - 2,5 mm thickness	20 mm	25/32"	82 mm	3-7/32"	145.0179	10
1	MC0340		heavy duty nozzle - 3 mm thickness	16 mm	5/8"	76 mm	3"	-	10
1	MC0568		quick release nozzle - 2,5 mm thickness	16 mm	5/8"	76 mm	3"	-	10
1	MC0576		quick release light nozzle - 2 mm thickness	16 mm	5/8"	76 mm	3"	-	10
2	MD0005-80		M8 - CuCrZr	1,0 mm	.040"	30 mm	1"-3/16	140.0316	10
2	MD0005-82		M8 - CuCrZr	1,2 mm	.045"	30 mm	1"-3/16	140.0445	10
2	MD0005-84		M8 - CuCrZr	1,4 mm	.052"	30 mm	1"-3/16	140.0536	10
2	MD0005-86		M8 - CuCrZr	1,6 mm	1/16"	30 mm	1"-3/16	140.0590	10
3	ME0076		M8 - brass			25 mm	31/32"	-	10
3	ME0083		M8 - brass			29 mm	1"-5/32	-	10
3	ME0390		M8 - copper			25 mm	31/32"	-	10
4	ME0074		plastic			28 mm	1"-3/32	-	10
4	ME0079		plastic			29 mm	1"-5/32	300029	10
4	ME0479		high-tech plastic			28 mm	1"-3/32	-	10
4	ME0579		ceramic	16 mm	5/8"	28 mm	1"-3/32	-	10
20	GM0530		uncoated steel liner	1,2 ÷ 1,6 mm	.045" ÷ 1/16"	3 m	10'	-	10
20	GM0531		uncoated steel liner	1,2 ÷ 1,6 mm	.045" ÷ 1/16"	4 m	12'	-	10
20	GM0532		uncoated steel liner	1,2 ÷ 1,6 mm	.045" ÷ 1/16"	5 m	16.4'	-	10

	CODE			
5	FB1278		insulator	10
5	MG0285		Ergoplus 400 torch head	1
6	MT0563		trigger kit	1
7	MT0560		handle kit	1
7	MT0566		pistol grip	1
8	MN2014-030		cable assembly - 3 m / 10'	1

	CODE			
8	MN2014-040		cable assembly - 4 m / 12'	1
8	MN2014-050		cable assembly - 5 m / 16.4'	1
9	AR0052		EURO connector	1
9	BW0020		metal EURO nut	10
9	FA0026		liner nut M10x1	10
9	MT0564		Back box kit	1

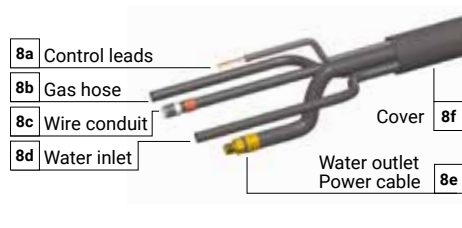

	CODE	↔
8a	BX1421-030	3 m / 10'
8b	QB0231-030	3 m / 10'
8c	QB0230-030	3 m / 10'
8d	QB0232-030	3 m / 10'
8e	QA0030-030	3 m / 10'
8f	MQ0125-030	3 m / 10'

	CODE	↔
8a	BX1421-040	4 m / 12'
8b	QB0231-040	4 m / 12'
8c	QB0230-040	4 m / 12'
8d	QB0232-040	4 m / 12'
8e	QA0030-040	4 m / 12'
8f	MQ0125-040	4 m / 12'

	CODE	↔
8a	BX1421-050	5 m / 16.4'
8b	QB0231-050	5 m / 16.4'
8c	QB0230-050	5 m / 16.4'
8d	QB0232-050	5 m / 16.4'
8e	QA0030-050	5 m / 16.4'
8f	MQ0125-050	5 m / 16.4'

STANDARD

ERGOPLUS 500

CE EN60974-7



CODE	↔			
MB2602-030	3 m	10'		1
MB2602-040	4 m	12'		1
MB2602-050	5 m	16.4'		1

CODE	↔			
MB2602X030	3 m	10'		20
MB2602X040	4 m	12'		20
MB2602X050	5 m	16.4'		15

TECHNICAL DATA		
ERGOPLUS 500		
	1,25 kg	2.76 lb
	113	
	1,0 ÷ 2,4 mm	.040" ÷ 3/32"
	500A CO2 - 450A Mix	
	2÷4 bar	
	1,6 l/min	

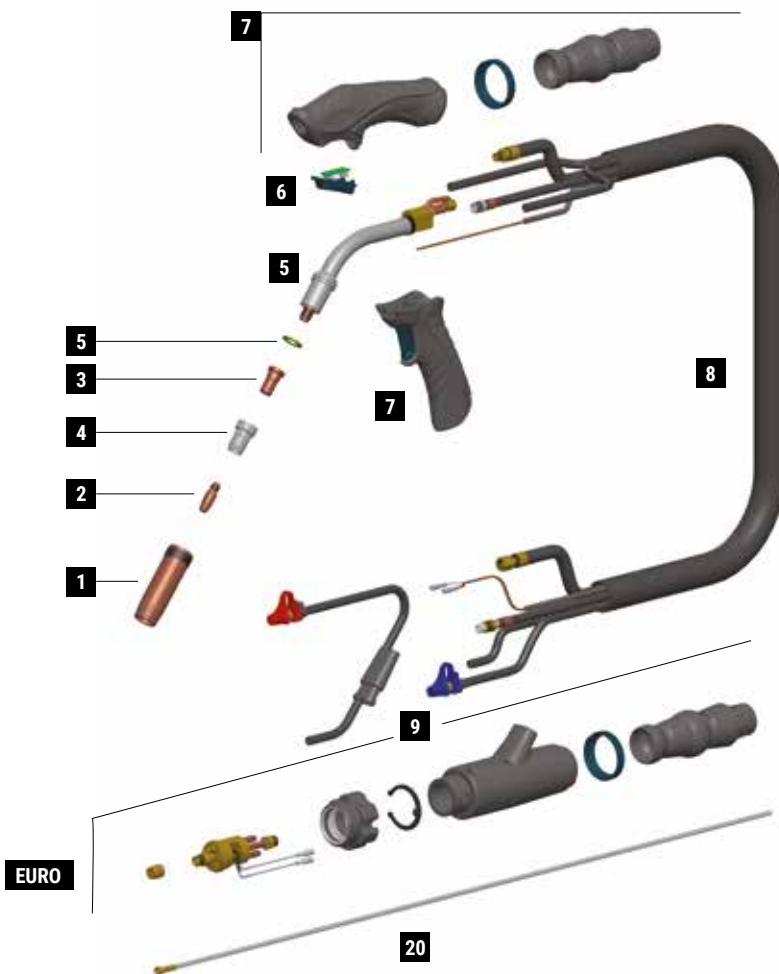

	CODE			Ø		↔	REF		
1	MC0268		nozzle - 2,5 mm thickness	16 mm	5/8"	76 mm	3"	145.0085	10
1	MC0276		nozzle - 2 mm thickness	16 mm	5/8"	76 mm	3"	145.0085	10
1	MC0290		nozzle - 2,5 mm thickness	14 mm	9/16"	76 mm	3"	145.0132	10
1	MC0291		nozzle - 2,5 mm thickness	20 mm	25/32"	76 mm	3"	145.0051	10
1	MC0292		nozzle - 2,5 mm thickness	15 mm	19/32"	76 mm	3"	-	10
1	MC0293		nozzle - 2,5 mm thickness	20 mm	25/32"	82 mm	3-7/32"	145.0179	10
1	MC0340		heavy duty nozzle - 3 mm thickness	16 mm	5/8"	76 mm	3"	-	10
1	MC0568		quick release nozzle - 2,5 mm thickness	16 mm	5/8"	76 mm	3"	-	10
1	MC0576		quick release light nozzle - 2 mm thickness	16 mm	5/8"	76 mm	3"	-	10
2	MD0005-80		M8 - CuCrZr	1,0 mm	.040"	30 mm	1"-3/16	140.0316	20
2	MD0005-82		M8 - CuCrZr	1,2 mm	.045"	30 mm	1"-3/16	140.0445	20
2	MD0005-84		M8 - CuCrZr	1,4 mm	.052"	30 mm	1"-3/16	140.0536	20
2	MD0005-86		M8 - CuCrZr	1,6 mm	1/16"	30 mm	1"-3/16	140.0590	20
3	ME0076		M8 - brass			25 mm	31/32"	-	10
3	ME0083		M8 - brass			29 mm	1"-5/32	-	10
3	ME0390		M8 - copper			25 mm	31/32"	-	10
4	ME0074		plastic			28 mm	1"-3/32	-	10
4	ME0079		plastic			29 mm	1"-5/32	300029	10
4	ME0479		high-tech plastic			28 mm	1"-3/32	-	10
4	ME0579		ceramic	16 mm	5/8"	28 mm	1"-3/32	-	10
20	GM0530		uncoated steel liner	1,2 ÷ 1,6 mm	.045" ÷ 1/16"	3 m	10'	-	1
20	GM0531		uncoated steel liner	1,2 ÷ 1,6 mm	.045" ÷ 1/16"	4 m	12'	-	1
20	GM0532		uncoated steel liner	1,2 ÷ 1,6 mm	.045" ÷ 1/16"	5 m	16.4'	-	1

	CODE			
5	FB1278		insulator	10
5	MG0286		Ergoplus 500 torch head	1
6	MT0563		trigger kit	1
7	MT0560		handle kit	1
7	MT0566		pistol grip	1
8	MN2014-030		cable assembly - 3 m / 10'	1

	CODE			
8	MN2014-040		cable assembly - 4 m / 12'	1
8	MN2014-050		cable assembly - 5 m / 16.4'	1
9	AR0052		EURO connector	1
9	BW0020		metal EURO nut	10
9	FA0026		liner nut M10x1	10
9	MT0564		Back box kit	1

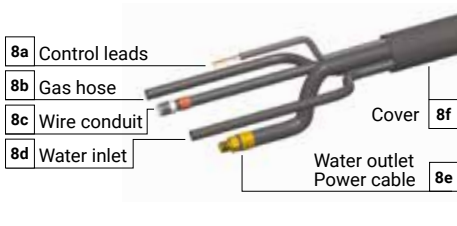

	CODE	↔
8a	BX1421-030	3 m / 10'
8b	QB0231-030	3 m / 10'
8c	QB0230-030	3 m / 10'
8d	QB0232-030	3 m / 10'
8e	QA0030-030	3 m / 10'
8f	MQ0125-030	3 m / 10'

	CODE	↔
8a	BX1421-040	4 m / 12'
8b	QB0231-040	4 m / 12'
8c	QB0230-040	4 m / 12'
8d	QB0232-040	4 m / 12'
8e	QA0030-040	4 m / 12'
8f	MQ0125-040	4 m / 12'

	CODE	↔
8a	BX1421-050	5 m / 16.4'
8b	QB0231-050	5 m / 16.4'
8c	QB0230-050	5 m / 16.4'
8d	QB0232-050	5 m / 16.4'
8e	QA0030-050	5 m / 16.4'
8f	MQ0125-050	5 m / 16.4'

STANDARD

ERGOPLUS 555

CE EN60974-7



CODE	↔			
MB2603-030	3 m	10'		1
MB2603-040	4 m	12'		1
MB2603-050	5 m	16.4'		1

TECHNICAL DATA	
	ERGOPLUS 555
	1,30 kg 2.87 lb
	113
	1,0 ÷ 2,4 mm .040" ÷ 3/32"
	550A CO2 - 500A Mix
	2÷4 bar
	1,6 l/min

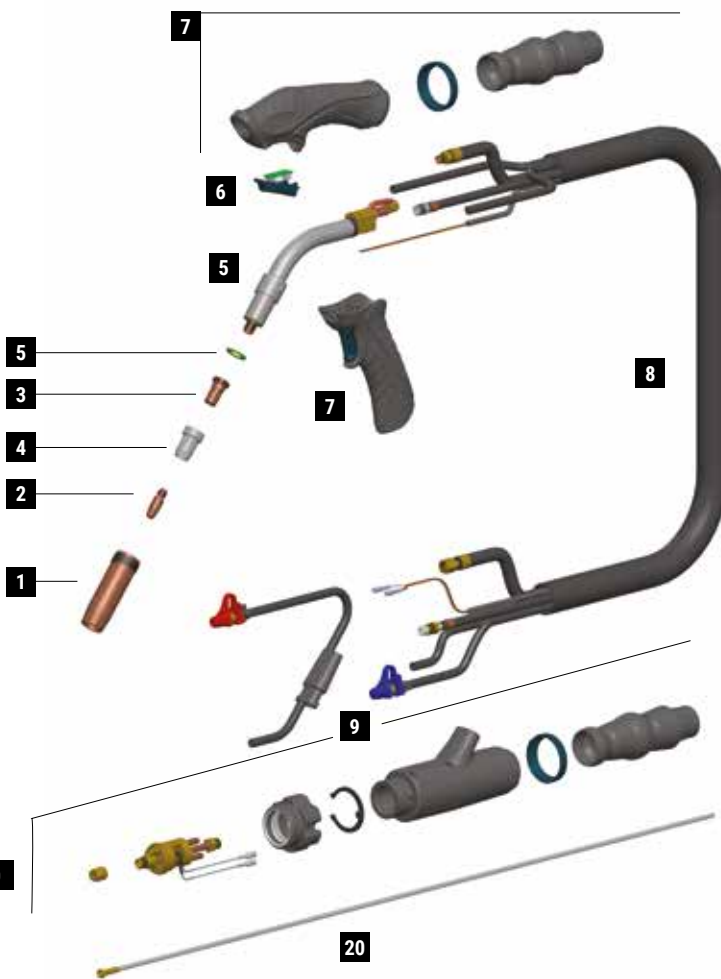

ERGOPLUS 555
REPAIR KIT FOR TORCH HEAD
MT0211

1

2

	CODE			Ø		↔	REF		
1	MC0268		nozzle - 2,5 mm thickness	16 mm	5/8"	76 mm	3"	145.0085	10
1	MC0276		nozzle - 2 mm thickness	16 mm	5/8"	76 mm	3"	145.0085	10
1	MC0290		nozzle - 2,5 mm thickness	14 mm	9/16"	76 mm	3"	145.0132	10
1	MC0291		nozzle - 2,5 mm thickness	20 mm	25/32"	76 mm	3"	145.0051	10
1	MC0292		nozzle - 2,5 mm thickness	15 mm	19/32"	76 mm	3"	-	10
1	MC0293		nozzle - 2,5 mm thickness	20 mm	25/32"	82 mm	3-7/32"	145.0179	10
1	MC0340		heavy duty nozzle - 3 mm thickness	16 mm	5/8"	76 mm	3"	-	10
1	MC0568		quick release nozzle - 2,5 mm thickness	16 mm	5/8"	76 mm	3"	-	10
1	MC0576		quick release light nozzle - 2 mm thickness	16 mm	5/8"	76 mm	3"	-	10
2	MD0005-80		M8 - CuCrZr	1,0 mm	.040"	30 mm	1"-3/16	140.0316	20
2	MD0005-82		M8 - CuCrZr	1,2 mm	.045"	30 mm	1"-3/16	140.0445	20
2	MD0005-84		M8 - CuCrZr	1,4 mm	.052"	30 mm	1"-3/16	140.0536	20
2	MD0005-86		M8 - CuCrZr	1,6 mm	1/16"	30 mm	1"-3/16	140.0590	20
3	ME0400		M8 - brass			25 mm	31/32"	-	10
3	ME0402		M8 - copper			25 mm	31/32"	-	10
4	ME0074		plastic			28 mm	1"-3/32	-	10
4	ME0079		plastic			29 mm	1"-5/32	300029	10
4	ME0479		high-tech plastic			28 mm	1"-3/32	-	10
4	ME0579		ceramic	16 mm	5/8"	28 mm	1"-3/32	-	10
20	GM0530		uncoated steel liner	1,2 ÷ 1,6 mm	.045" ÷ 1/16"	3 m	10'		1
20	GM0531		uncoated steel liner	1,2 ÷ 1,6 mm	.045" ÷ 1/16"	4 m	12'		1
20	GM0532		uncoated steel liner	1,2 ÷ 1,6 mm	.045" ÷ 1/16"	5 m	16.4'		1

	CODE			
5	FB1278		insulator	10
5	MG0287		Ergoplus 555 torch head	1
6	MT0563		trigger kit	1
7	MT0561		handle kit	1
7	MT0566		pistol grip	1
8	MN2014-030		cable assembly - 3 m / 10'	1

	CODE			
8	MN2014-040		cable assembly - 4 m / 12'	1
8	MN2014-050		cable assembly - 5 m / 16.4'	1
9	AR0052		EURO connector	1
9	BW0020		metal EURO nut	10
9	FA0026		liner nut M10x1	10
9	MT0564		Back box kit	1

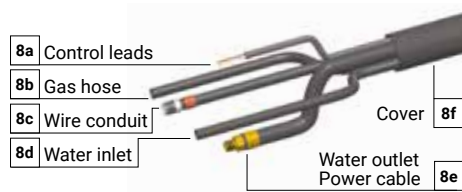

	CODE	↔
8a	BX1421-030	3 m / 10'
8b	QB0231-030	3 m / 10'
8c	QB0230-030	3 m / 10'
8d	QB0232-030	3 m / 10'
8e	QA0030-030	3 m / 10'
8f	MQ0125-030	3 m / 10'

	CODE	↔
8a	BX1421-040	4 m / 12'
8b	QB0231-040	4 m / 12'
8c	QB0230-040	4 m / 12'
8d	QB0232-040	4 m / 12'
8e	QA0030-040	4 m / 12'
8f	MQ0125-040	4 m / 12'

	CODE	↔
8a	BX1421-050	5 m / 16.4'
8b	QB0231-050	5 m / 16.4'
8c	QB0230-050	5 m / 16.4'
8d	QB0232-050	5 m / 16.4'
8e	QA0030-050	5 m / 16.4'
8f	MQ0125-050	5 m / 16.4'

STANDARD

A large area of the page is filled with horizontal dashed lines, providing a template for writing or drawing.

A series of horizontal dashed lines spanning the width of the page, intended for handwritten notes or data entry.

**Trafimet Group Spa**

Via del Lavoro, 8
36020 Castegnero
Vicenza, Italy
Ph. +39 0444739900
Fax +39 0444739999
info@trafimet.com

Trafimet Schweisstechnik GmbH

Im Gewerbegebiet 20
36289 Friedewald
Deutschland
Ph. +49 66749000
Fax +49 667490028
info@trafimet.de

Trafimet Kaynak Sistemleri A.Ş.

İkitelli O.S.B. Heskop H Blok
Sinpaş İş Modern Ticaret Merkezi
Kat.3 No.66 Başakşehir 34490
İstanbul, Türkiye
Ph. +90 212 8091700
Fax +90 212 8091703
info@trafimet.com.tr

Italy

Ph. +39 0444 739800
Fax +39 0444 739899

Export

Ph. +39 0444 739900
Fax +39 0444 739999

© 2022 Trafimet Group SpA a socio unico
Edition 01/2022
Code EA2771

All Trademarks are exclusive property of the respective companies.
Data and images are indicative and may be changed in any time without notice

Distributor